

Charging Cart Instructions

08/04/15

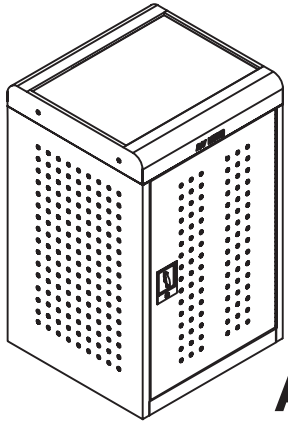

A x1

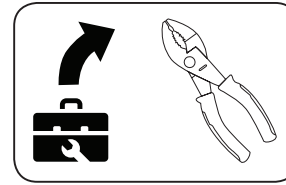
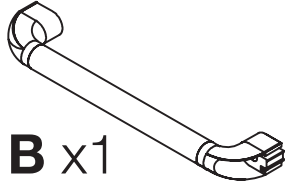

B x1

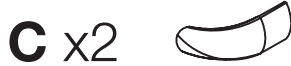

C x2



D x1

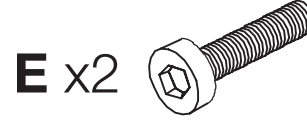

E x2



F x1

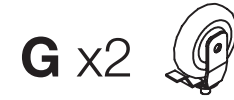

G x2



H x2



J x1



K x1



L x2

1

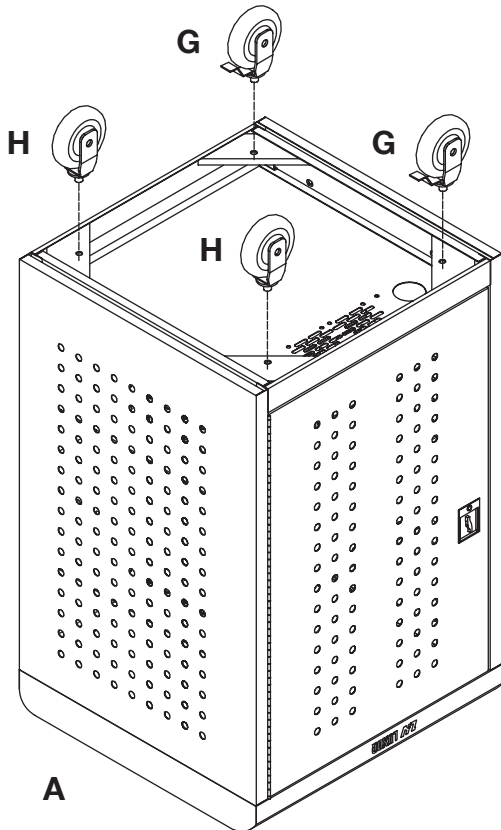

2

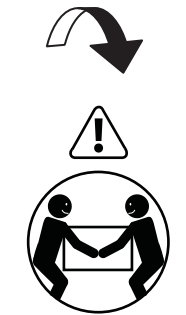

Heavy Lifting:
Assistance
Required

