

Voyager Legend[®] CS

Bluetooth Headset System

User Guide

Welcome

Congratulations on purchasing your new Plantronics product. This guide contains instructions for setting up and using your Voyager Legend CS Wireless Headset System.

Please refer to the separate safety instructions for important product safety information prior to installation or use of the product.

What's in the Box

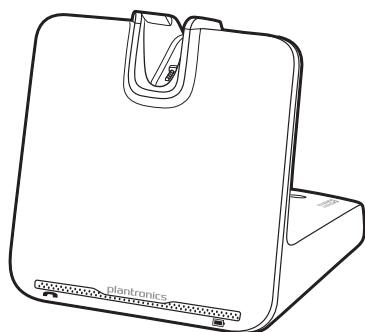

Base

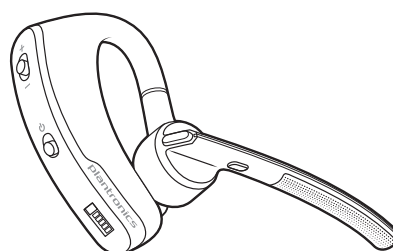

Headset

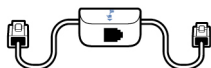

Telephone interface cable

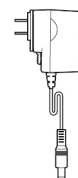

Power supply

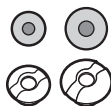

Eartips

Some models may also include:

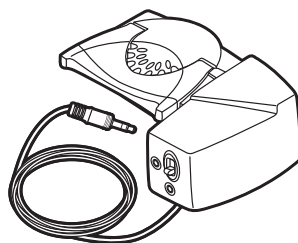

HL10 Lifter

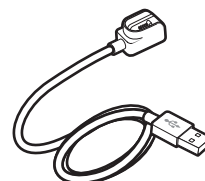

USB Charge cable

Base and Headset Basics

Base

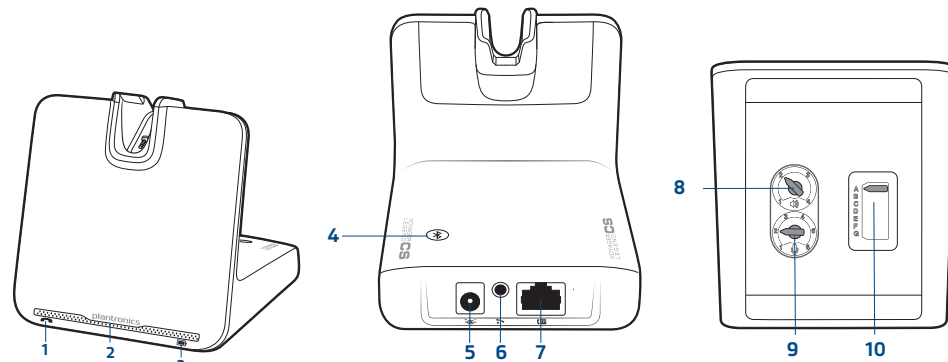

- 1 Call/mute LED
- 2 Power on/pairing LED
- 3 Charging LED
- 4 Pairing button
- 5 Power jack

- 6 Handset lifter/EHS cable jack
- 7 Telephone interface cable
- 8 Listening volume dial*
- 9 Speaking volume dial*
- 10 Configuration switch*

*For installation set up

Headset

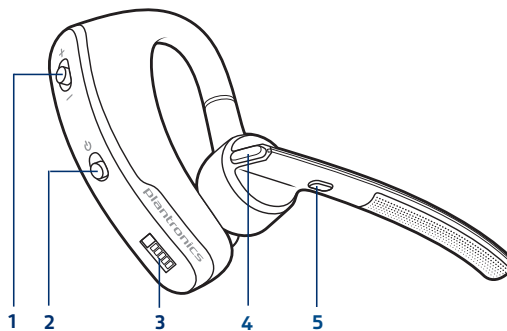

- 1 Volume +/- button
- 2 Power button
- 3 Snap fit magnetic charge connection

- 4 Call button
- 5 Mute microphone/voice command button

Accessories

Sold separately.

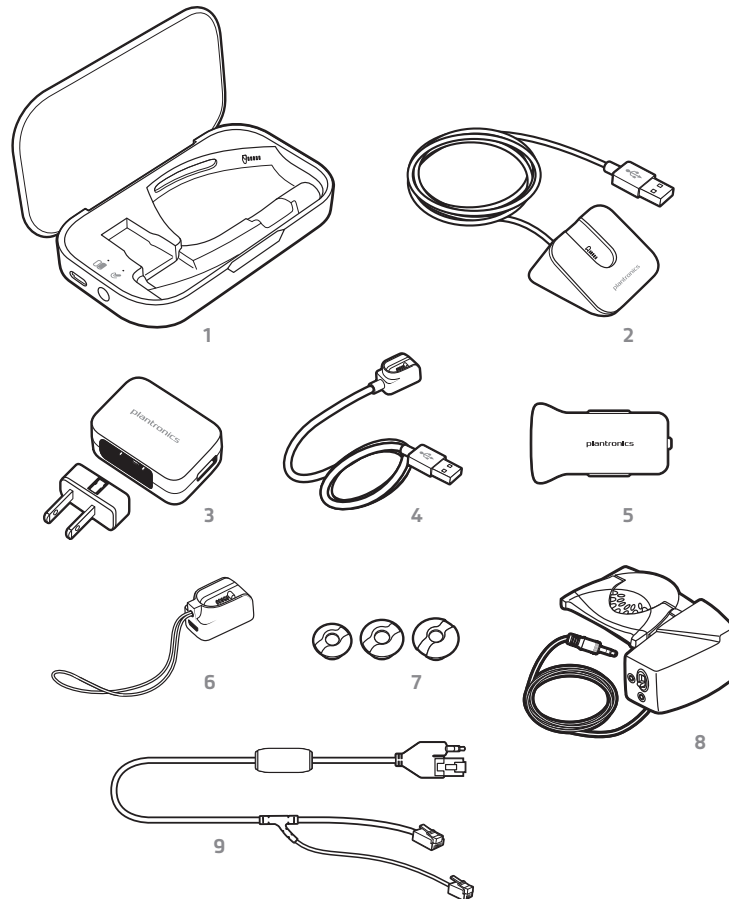

- 1 Portable charge case**
- 2 Desktop charge stand**
- 3 AC charger**
- 4 USB charge cable***
- 5 Car charge adapter**
- 6 Micro USB charge adapter**
- 7 Eartip kit** (available in S, M, L)
- 8 HL10 lifter*** Automatically lifts handset and returns it to the cradle. Enables remote call control with your headset.
- 9 Electronic hookswitch cable (EHS cable)** Electronically and automatically takes your desk phone handset off hook. Enables remote call control with your headset.

*Included with some models.

Fit

Change the eartip

Change the eartip for a better fit.

- 1 Push in eartip and rotate to the left to unlock it.

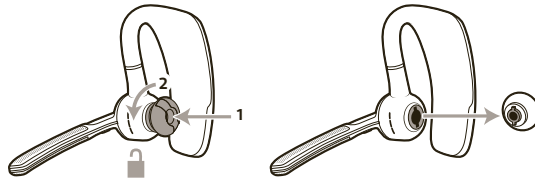

- 2 Align new eartip into slot.

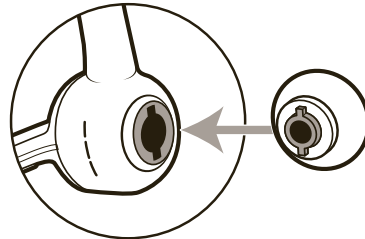

- 3 Rotate it to the right to lock it into place.

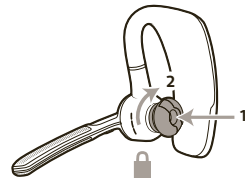

Wear on the left or right

To wear the headset on your other ear, rotate the boom upwards then twist it around so the eartip is on the other side before lowering the boom.

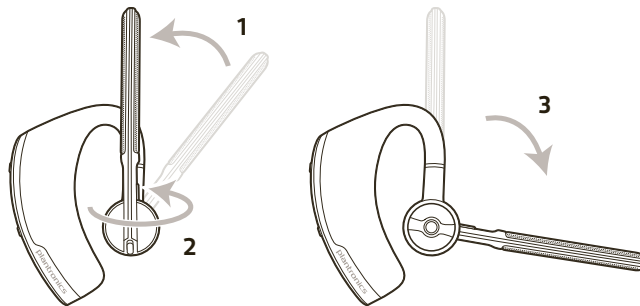

Connect Your Desk Phone

Connect the power

Plug one end of the power supply into the power jack on the back of the base and the other end into a working power outlet. The Power On LED will be solid white.

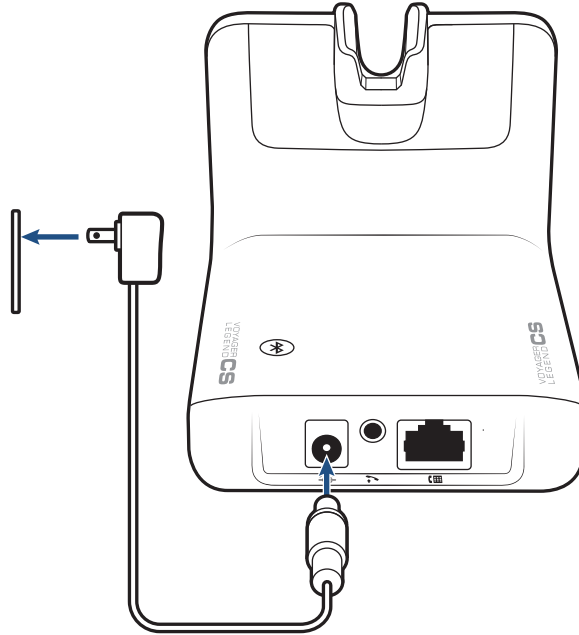

Charge the headset

Place the headset in the charge cradle. The charging LED on the base will flash blue when charging and turn solid blue when the headset is fully charged. Charge for at least 20 minutes prior to the first use. A full charge takes 90 minutes.

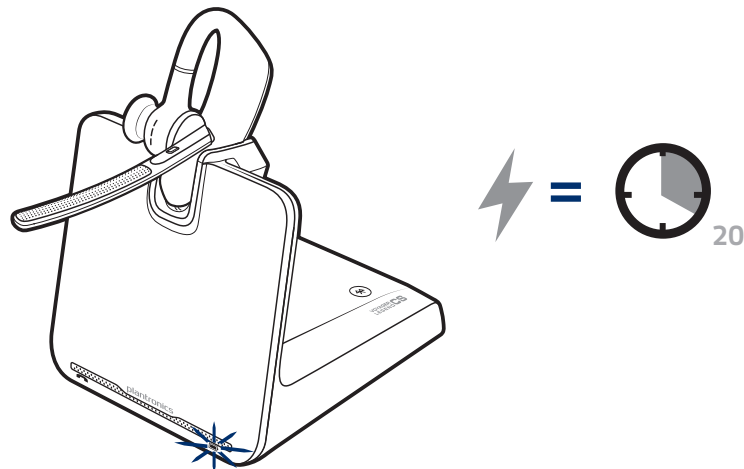

Connect and configure your desk phone

There are three setup options for connecting the Voyager Legend CS to your desk phone. Select one of the following and continue.

- Desk phone (standard)
- Desk phone + HL10 Lifter (sold separately)
- Desk phone + EHS cable (sold separately)

NOTE If you will be using a standard desk phone set up or a desk phone with an HL10 lifter, continue below. If you will be using the desk phone with an EHS cable, refer to Desk phone plus EHS cable section in this guide. For further installation information refer to the EHS Getting Started guide that came with your EHS cable or at plantronics.com/accessories.

Desk phone (standard)

- 1 Connect one end of the telephone interface cable to the back of the base.
- 2 Disconnect the handset coil cord from the desk phone and re-connect it to the telephone interface cable junction box.
- 3 Connect the remaining end of the telephone interface cable into the open handset port on the desk phone.

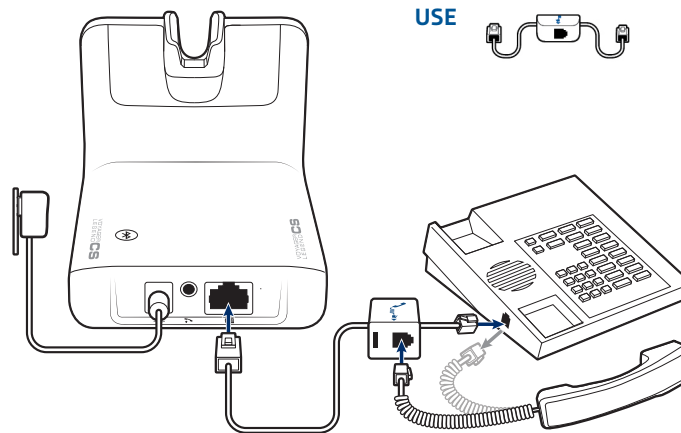



NOTE Your desk phone handset will continue to work; it's just hooked up differently.

NOTE If your phone has a built-in headset port, you should only use the headset port if you will not be using the HL10 lifter. In this configuration, you must first press both the headset button on your phone and the call control button on the headset to answer or end calls.

Check configuration and make a test call

- 1 If your desk phone has a volume control set it to mid range.
- 2 Look at the bottom of your base and make sure the default settings are correct. Set your desk phone's volume also.

Set the listening volume dial  and the speaking volume dial  to 2.

Set the configuration switch to A.

Set the desk phone volume to mid-range.

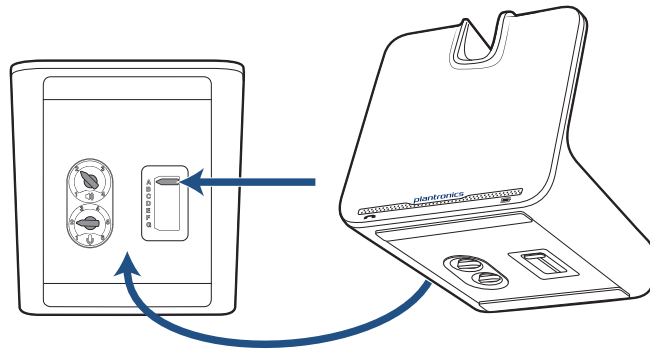

- 3 Remove the handset from the desk phone cradle.
- 4 While wearing your headset, press the call button on the handset.
- 5 If you do not hear a dial tone, adjust the configuration switch (A-G) until you do.
NOTE For most phones, these factory settings will sound best.
- 6 Dial a test call from the desk phone. If needed, fine tune the volume with the headset volume controls. You can also adjust the desk phone speaking and listening volumes on the bottom of the base.

Desk phone plus HL10

First follow the steps above for **Desk phone (standard)**.

- 1 Firmly press the handset lifter power cord into the handset lifter jack.

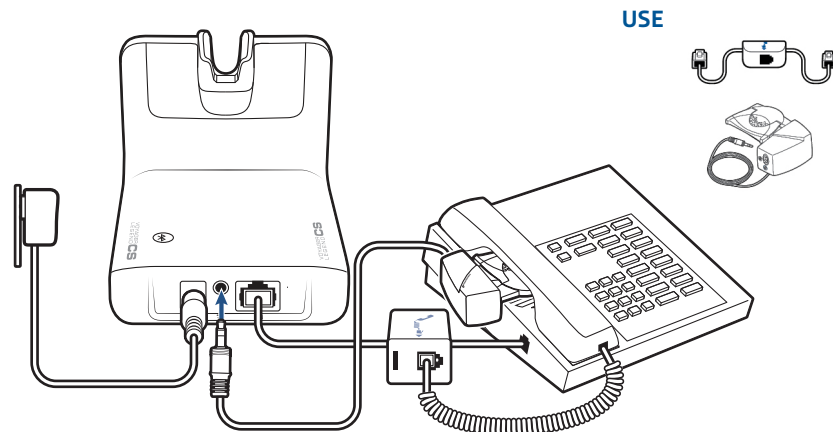

- 2 While wearing your headset, slide the handset lifter arm under the handset until the lifter base touches the side of the phone.

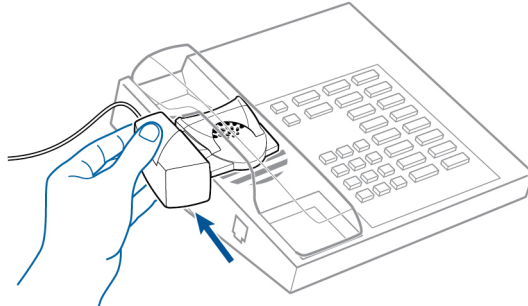

- 3 Slide the lifter up to where it nearly touches the handset earpiece.
- 4 Press the call button on your headset to activate the lifter.
- 5 If you hear a dial tone the lifter is set correctly and needs no adjustment.
- 6 Remove the protective strips from the 3 mounting tapes on the underside of the lifter.
- 7 Gently place the lifter on the desk phone in the pre-determined position.
- 8 Press firmly to adhere.

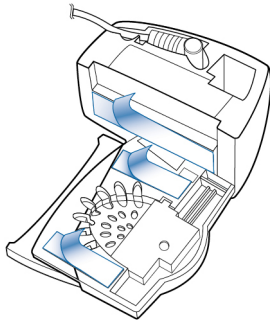

Desk phone plus EHS cable

Connect the end of the EHS cable to the base and the other end of the desk phone as described in the EHS Quick Start Guide.

NOTE For further installation information refer to the EHS Quick Start Guide that came with your EHS cable or at www.plantronics.com/accessories.

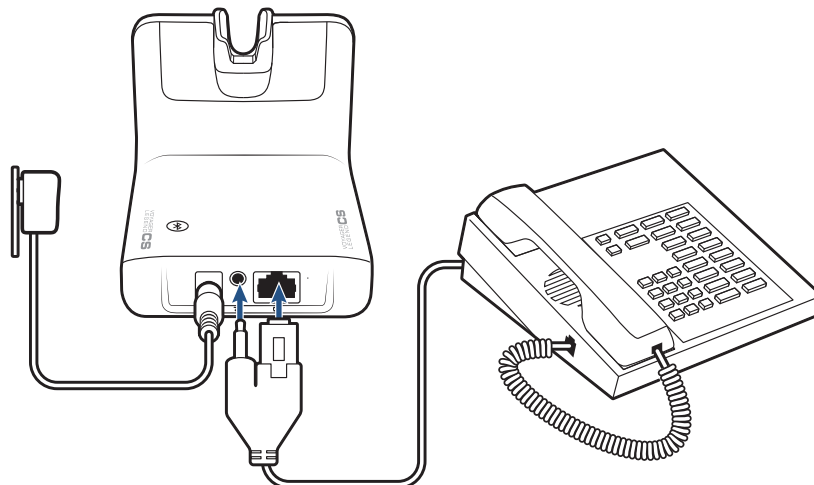

Position your base



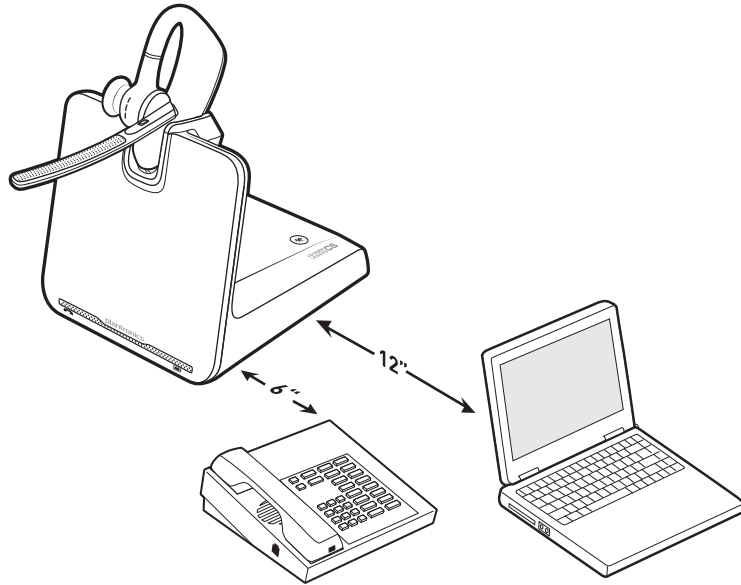



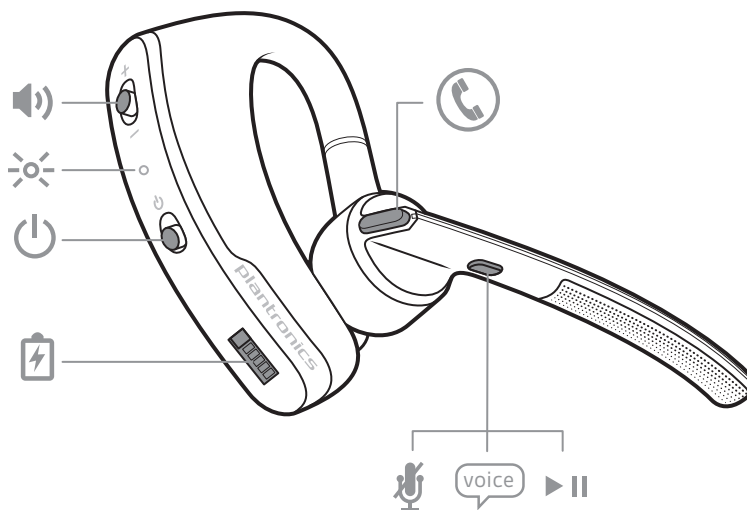

The minimum recommended separation between your desk phone and the base is 6 inches. The minimum recommended separation between the base and computer is 12 inches. Incorrect position can cause noise and interference problems.



Headset Overview

Headset Controls



	Call button	
	Volume button	
	Headset LED (indicator light)	
	Power button	
	Magnetic charge port	
	Mute button	
	Voice button	(mobile phone use only)
	Play/Pause button	(mobile phone use only)

Talk time

With a single full charge, the Voyager Legend CS will provide up to 7 hours of talk time and up to 11 days of standby time.

Adjust the volume

Toggle the Volume button (show icon) up (+) or down (-) during a call to adjust the volume. While not on a call you can toggle the Volume button (show icon) to adjust the volume level for voice prompts and notifications.

Out of range indications

The wireless range for the Voyager Legend headset is 10M from the desktop base or your mobile phone. Audio quality can be expected to degrade past 10M and wireless connectivity eventually stop when range limits are exceeded.

When you leave the operating range of the base or mobile phone, a voice prompt will announce:

- "Phone 1 Disconnected"; any audio is terminated

NOTE Note: If both desk phone and mobile phone are connected to the headset it will be announced "Phone 1 Disconnected" and "Phone 2 Disconnected" as connections are lost

When you return to the operating range of the base or mobile phone, a voice prompt will announce:

- "Phone 1 Connected"; audio restored if active

NOTE *Note: If both desk phone and mobile phone are connected to the headset it will be announce "Phone 1 Connected" and "Phone 2 Connected" as connections restored.*

Low battery warnings

Battery Level	Tone	Voice Prompt
30 minutes of talk time remaining (this alert only occurs during an active call)	Double high tone every 15 minutes	"Battery Low" repeats every 30 minutes
10 minutes of talk time remaining	Triple high tone every 30 seconds	"Recharge Headset" every 3 minutes

Base LEDs

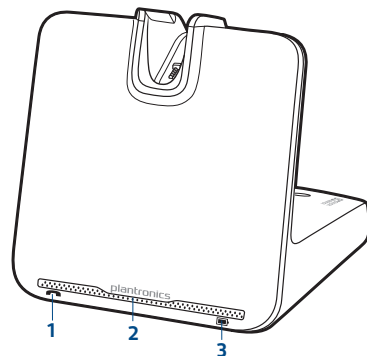

1 Call Status LED

Idle = Unlit
Incoming call = fast blue flash
On call = solid blue
Call (headset mic) muted = slow blue flash

2 Power On/Pairing LED

Power off = unlit
Powered = solid blue (headset paired/connected)
Powered = solid red (headset not paired or disconnected)
In pairing mode = red/blue flashing
Pairing successful = solid blue

3 Headset Battery LED (when docked)

Full battery, charging stopped = solid blue
High, charging = 3 blue flashes every 10 seconds
Medium, charging = 2 blue flashes every 10 seconds
Low, charging = 2 red flashes every 10 seconds
Critical, charging = 3 red flashes every 10 seconds

Your Base : Pairing

Pairing your base to your headset

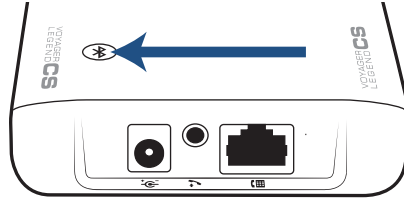

Bluetooth pairing button



The headset and base that came in the box are already paired to each other. However, if you wish to use a new headset or need to restore subscription to your current headset, the units can be paired to each other by doing the following.

Pairing headset

- 1 Press and hold the Bluetooth pairing button  until the power LED (middle) flashes RED/BLUE.
- 2 Switch on your headset and do either of the following:
 - Tap the Voice Button and say "Pairing Mode"
 - Press and hold the call button until you hear "Pairing"The power LED will turn solid blue once paired.

Pair phone or tablet

Pair your headset to your phone or another device, such as a tablet.

- 1 Switch on your headset then choose:
 - Tap the Voice button  and say "Pair mode," or
 - Press and hold the Call button  until you hear "Pairing"
- 2 While the headset LEDs are flashing red and blue, activate Bluetooth® on your phone and set it to search for new devices.
- 3 Select "PLT_Legend."

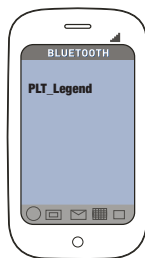

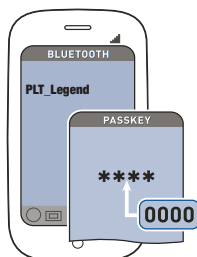

- 4 If your phone asks for a passcode, enter four zeros (0000) for the passcode or accept the connection.



- 5 Once successfully paired, LEDs stop flashing red and blue. The LED remains solid blue and you hear "pairing successful."

NOTE *To enable caller name announcement, allow access to your contacts if your phone prompts you.*



Call Controls - Desk Phone





- Place a call**
- 1 Wearing the headset, press the Call button .
 - 2 Remove the handset from the cradle, you will hear dial tone.
This step will be automatic if you install a handset lifer or EHS cable accessory. For a complete list of accessories, visit www.plantronics.com/accessories
 - 3 Dial the number using your desk phone.
 - 4 To end the call, press the headset Call button  and hang up the handset.

- Answer a Call**
- 1 If wearing the headset, press the Call button , or
 - 2 If not wearing the headset, place the handset on your ear; the call will be answered automatically.
 - 3 Remove the handset from the cradle, your call is now active.
This step will be automatic if you install a handset lifer or EHS cable accessory. For a complete list of accessories, visit www.plantronics.com/accessories











Reject a call (desk phone) Use the Call Reject function on your desk phone, if supported.

End a call Press the Call button  to end current call.

- Mute a call**
- 1 MUTE ON: During a call press the Mute button , you will hear the "mute on" voice prompt which indicates the headset microphone is muted. The mute reminder is repeated every 15 minutes alternating between the voice prompt and a tone.
 - 2 MUTE OFF: During a call while muted, press the Mute button , you will hear "mute off", which unmutes the headset microphone.

- Answer a second incoming call**
- 1 SECOND CALL ON DIFFERENT PHONE: Press the Call button  to end the first call, then press the Call button  again to answer the second call.
 - 2 ON DESK PHONE, SECOND DESK PHONE CALL: Press the Call button  to end the first call then, if supported by your phone, press the Call button  again to answer the second call.
Note: Your desk phone may also have second call management features which are better suited for specific second call management needs.

Call Controls - Mobile Phone

- Place a call**
- 1 Wearing the headset, press the Call button .
 - 2 Dial the number using mobile phone.
 - 3 To end the call, press the Call Button  on the headset or end via your mobile phone.
- Answer a call**
- 1 If wearing your headset press Call Button , or
 - 2 If wearing the headset and prompted, "Incoming call, answer or Ignore", say "Answer", or
 - 3 If not wearing your headset, place the headset on your ear; the call will be answered automatically.
- Reject a call**
- 1 Press the Call Button  for 2 seconds, or
 - 2 Say "Ignore" when prompted, or
 - 3 Use the Call Reject function of your mobile phone, if supported.
- End a call**
- Press the Call button  to end current call.
- Mute a call**
- 1 MUTE ON: During a call press the Mute button , you will hear the "mute on" voice prompt which indicates the headset microphone is muted. The mute reminder is repeated every 15 minutes alternating between the voice prompt and a tone.
 - 2 MUTE OFF: During a call while muted, press the Mute button , you will hear "mute off", which unmutes the headset microphone.
- Answer a second incoming call**
- 1 SECOND CALL ON DIFFERENT PHONE: Press the Call button  to end the first call, then press the Call button  again to answer the second call.
 - 2 ON MOBILE PHONE CALL, SECOND MOBILE CALL: Press the Call button  once to end current call, then say "answer" when prompted to answer the second call.
NOTE *Your mobile phone may also have second call management features.*

Customize Your Headset

Your headset understands and speaks in English. You can change the language and other settings online.

MyHeadset™ Updater tool enables you to:

- Receive firmware updates
- Change language for voice alerts and commands (English U.K., French, German, and Spanish. Voice alerts are also available in Cantonese and Mandarin.)
- Change regional phone number for Vocalyst service
- Turn voice commands on/off
- Turn Smart Sensors™ on/off
- Turn high quality audio (A2DP) streaming on/off
- Turn "mute off" voice alert on/off

Features

Listen to audio via A2DP

Your Voyager Legend headset can play media files (music, podcasts, navigation, etc.) from any A2DP (Advanced Audio Distribution Profile for Bluetooth)-enabled mobile device.

Transmission range

Your Voyager Legend Bluetooth headset has a 10 meter effective range. Voice prompts from your headset will alert you if you lose connection with your base or mobile phone.

Simultaneous call handling behavior (PC Mobile)

You can be on a call using a computer softphone application and receive a mobile phone call. The ringtone for the mobile phone call is heard in the headset. Tapping the call button on the headset will end the computer softphone call. Tapping the call button again will answer the mobile phone call.

NOTE *Answering the call on your mobile phone sends the audio to the mobile phone and leaves the computer softphone call active on the headset.*

You can be on a mobile phone and receive a call on your computer softphone. The ringtone for the computer softphone call is heard in headset during the call.

Tapping the call button on the headset ends the mobile phone call. Tapping the call button again answers the computer softphone call.

If you receive a computer softphone call and mobile call at the same time, tapping the call button will pick up the call that came in first.

Voice alerts

Your headset speaks English.

Voice alerts list

- "Battery low/medium/high"
- "Connection switched"
- "Headset connected"
- "Not connected"
- "Mute on/off"
- "Pairing"
- "Pairing successful"
- "Power on/off"
- "Recharge headset"
- "Redial"

Voice commands

Tap the Voice button , wait for command request, then say a command. For example, "What can I say?" tells you the full list of available commands. You can change the voice command language by visiting and downloading the MyHeadset™ Updater tool. The available languages are English (US and UK), French, German, Italian, Japanese, Korean, Mandarin, Russian, Spanish and Swedish. Voice commands for Cantonese, Danish and Norwegian must be spoken in English.

Voice commands list

- "Am I connected?"
- "Answer"
- "Call information"
- "Call Vocalyst"

- "Cancel"
- "Check battery"
- "Ignore"
- "Pair mode"
- "Redial"
- "What can I say"

NOTE *The voice-dial feature on your phone is initiated by pressing the Call button  for 2 seconds. The voice-dial feature is not a headset voice command and only works with supporting phones.*

Disable the answer/ignore voice commands

To disable the "answer/ignore" voice commands:

- 1 Switch on the headset.
- 2 Press and hold the Voice button until you hear a double tone.
- 3 Repeat to reactivate the voice answer commands.

Troubleshooting

Headset

Talk time performance is significantly degraded even after a full recharge.

Battery is wearing out. Contact us at www.plantronics.com/support.

Desk phone

I can't hear a dial tone in the headset.

Make sure your headset is charged.
Make sure your headset is subscribed to base. See Subscription button.
Press the call control button on your headset.
If using a lifter, make sure the lifter is lifting the handset high enough to operate the hookswitch; set to a higher setting if necessary.
Adjust the configuration switch on the base until a dial tone is heard. operate the hookswitch; set to a higher setting if necessary.
Fine tune the listening volume on the headset.
If the volume is still too low, adjust the Listening volume dial on the base.

I hear static.

Make sure there is at least 12 inches between your base and your computer, and 6 inches between your base and your telephone. You may hear static as your headset is going out of range; move closer to the base.

The sound is distorted.

Lower the Speaking volume dial or Listening volume dial on the base. For most telephones the correct setting is position 2.
If your desk phone has a volume control, lower until the distortion disappears.
If the distortion is still present, adjust the headset volume control to lower the headset speaker volume. If the distortion persists, lower the Listening volume dial on the base.
Make sure there is at least 12 inches between your base and your computer, and at least 6 inches between your base and your telephone.

I hear echo in the headset.

Lower the Listening volume dial and Speaking volume dial on the base. For most telephones, the correct setting is position 2.
If the audio level is too low in this position, adjust the headset volume control to increase the headset speaker volume.
If your speaking volume is too low for your listener in this position, adjust the position of the headset to make sure the microphone is a finger's width from the corner of your mouth.
Adjust the Configuration switch. The most commonly used position is "A".

People I talk to can hear a buzz in the background.

Move the base further away from your phone.
If the base power supply is plugged into a power strip, plug it into the wall directly.

The handset lifter is installed but does not lift the handset.

Be sure the handset lifter power cord is firmly pushed into the handset lifter jack on the base.

NEED MORE HELP?

www.plantronics.com/support

Plantronics, Inc.

345 Encinal Street
Santa Cruz, CA 95060
United States

Plantronics BV

South Point Building C
Scorpius 140
2132 LR Hoofddorp

© 2013 © 2013 Plantronics, Inc. All rights reserved. Plantronics and Voyager Legend are trademarks or registered trademarks of Plantronics, Inc. The Bluetooth® word mark and logos are owned by the Bluetooth SIG, Inc. and any use of such marks by Plantronics, Inc. is under license. All other trademarks are the property of their respective owners.

Patents: US 8,208,673; D617,316; D681,003; 681,014; D681,002; D662,089; BR 3020120011493; CN ZL201230489876.9; ZL201230059196.3; EM 002109637-0001; 002109637-0002; 002109637-0003; 001315261-0001; IN 243252; TW D151481; Patents Pending

201137-06 (09.13)