

# Signal Booster Installation Guide



## Sleek® 4G

Cell Phone Signal Booster with Built-in Antenna

U.S. Patent Nos. – D626,953; 7,684,838; 7,221,967; 7,729,669;  
7,486,929; 7,729,656; 7,409,186; 7,783,318

### Contents:

Accessories .....	1
How it Works .....	2
Vehicle Installation Diagram .....	2
Install the Outside Antenna .....	2
Power up the Wilson Electronics Sleek 4G .....	3
Adjusting the Sleek 4G Arms .....	4
Understanding the Sleek 4G Lights .....	4
Troubleshooting .....	4
In-Building Installation .....	5
Warnings .....	6
About Wilson Electronics .....	6
Signal Booster Specifications .....	Back Cover

To boost your phone's signal power, the phone must be placed in the Sleek 4G cradle. For best results, use a Bluetooth® headset or hands free device, while the phone remains in the Sleek 4G.

**Note:** This manual contains important safety and operating information. Please read and follow the instructions in this manual. Failure to do so could be hazardous and result in damage to your Sleek.

Appearance of device and accessories may vary.



Sleek® 4G operates on (Band 12/17, 13) 700 / 800 / AWS 1700 - 2100 / (Band 25) 1900 MHz  
Model #2B3425 FCC: PWO2B3425

FCC requires to never use the cell phone in the cradle next to your ear.

## Inside this Package



Sleek® 4G Cell Phone  
Signal Booster



Mini-Magnet  
Mount Antenna  
**(301126)**  
(included in some kits)



5.5V / 2A  
Power Supply  
& USB cable  
**(859999)**



Vehicle Dash Adhesive  
Mounting Bracket  
& Adjustable Arms

**NOTE:** If product #813425 was ordered, package will only include Sleek 4G wireless Signal Booster cradle, power supply, and mounting bracket.

## General

Your Wilson Electronics Sleek 4G has been carefully engineered to significantly improve the performance of your phone. Together with an Outside Antenna, the Sleek's state-of-the-art circuitry is designed to increase your phone's signal to and from the cell tower. The Sleek 4G reduces disconnects and dropouts and increases data communication rates on 2G, 3G and 4G networks.

## Accessory Kit

\* All 3 available together in the Home Accessory Kit - 859970 (carrying case included)



AC Power Supply  
**\*(859969)**



Antenna Window Mount  
(Used with Mini-Magnet Mount Antenna)  
**\*(901128)**



Adjustable Desk Mount  
**\*(901137)**

## Additional Accessories for the Sleek® 4G



Mobile Power  
Supply  
**(859984)**



Gooseneck  
Suction Cup  
Cradle Mount  
**(901120)**



Cup Holder  
Cradle Mount  
**(901130)**



Adhesive Mount



Rugged / Screw  
Mount



Vent Clip Mount

Vehicle Dash Mounting Kit  
**(901134)**  
(included in some kits)

Appearance of device and accessories may vary.  
(This product is not marketed by Verizon Wireless or AT&T)

1

Contact Wilson Electronics Technical Support Team with any questions at 866-294-1660  
or email: [tech@wilsonelectronics.com](mailto:tech@wilsonelectronics.com). Mon. - Fri. Hours: 7 am to 6 pm MST.

## How it Works

With the phone in the cradle and while using a wireless Bluetooth® headset (or hands free device) the Outside Antenna collects the cell tower signal and sends it through the cable to the Sleek 4G. The signal is then boosted by the Sleek 4G and sent to the phone. When the phone transmits, the signal is picked up wirelessly and boosted by the Sleek 4G and transmitted back to the cell tower through the Outside Antenna.

**NOTE:** The cell phone must be placed in the cradle to work properly.

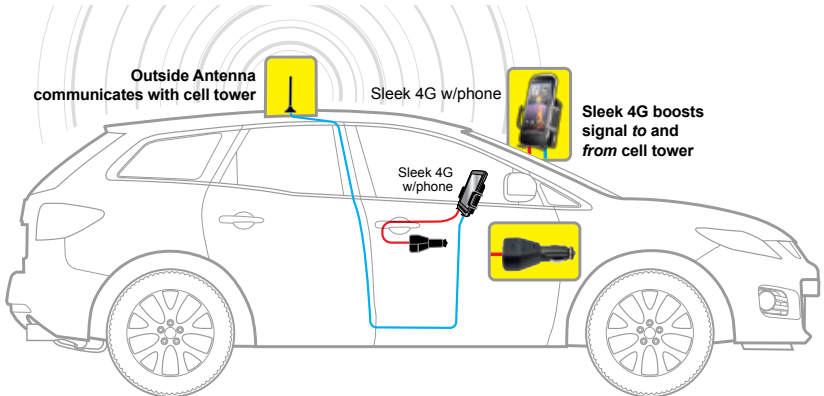

**Warning:** DO NOT use phone covers that have chrome or any other metallic surface. It may block cellular signals.

**NOTE:** See the Warnings section for additional information.

## Vehicle Installation

### 1. Install the Outside Antenna

To receive the best cell signal, select a location for the Outside Antenna that is preferably in the center of the vehicle's roof, 12 inches away from any other antennas, free of obstructions, and at least 6 inches from the rear and side windows or sunroof.

The Outside Antenna must be installed vertically. Antenna performance will be degraded if the antenna is not vertical. The antenna cable is small yet strong enough that it may be shut in most vehicle doors without damaging the cable.

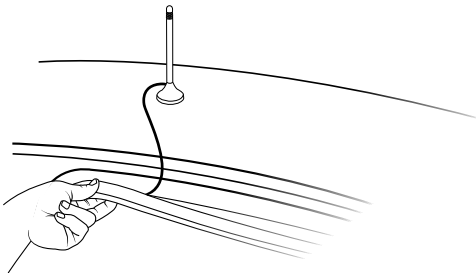

**NOTE:** For a more professional looking installation, run the antenna cable under the door seal. Carefully pull down the door seal. Run the cable under the seal and push the seal back into place. This prevents constant wear and tear on the cable as the door opens and closes. The antenna cable is small enough to easily tuck under the door seal or plastic molding.

## 2. Attach the Mounting Bracket

(included in this package)

- Clean the area where the bracket is to be mounted with the supplied alcohol wipe. Allow to dry.
- Peel the backing to expose the adhesive and press the bracket onto the desired location in the vehicle. **Note:** *Be sure the tab is positioned vertically, not horizontally.*
- Allow the adhesive to cure for 24 hours before you attach the Sleek 4G.**

## 3. Attach the Sleek® 4G to the Bracket

Once you have installed the bracket in the desired location, and waited 24 hours for adhesive to cure, attach the Sleek 4G by aligning the rectangular hole on its back with the tab on the mount bracket, grasping the sides of the Sleek 4G, and sliding it downward approximately ¼ inch into place. You can adjust the angle of the adhesive bracket by applying gentle pressure to the top or bottom of the Sleek 4G. The bracket is designed to swivel when the knurled nut is loosened for greater adjustability of the Sleek 4G viewing angle. To lock bracket into position, tighten large nut.

## 4. Attach the Outside Antenna cable to the Sleek® 4G

Attach the cable from the Outside Antenna to the antenna connector on the Sleek 4G (see Figure 1).

## Power up the Wilson Electronics Sleek® 4G

Connect the mini-USB plug on the power supply cable to the mini-USB port located on the bottom of the Sleek 4G (refer to Figure 1) and insert the vehicle power adapter into the power socket of your vehicle.

The switch located on the right hand side of the Sleek 4G should be set to the desired position. **Up Position:** Is for Verizon LTE.

**Down Position:** is for AT&T LTE (refer to Figure 2).

The Sleek 4G may remain on all the time. However, leaving the Sleek 4G on in a vehicle when it is not running can discharge the battery in a day or two.

**NOTE:** *Make sure the Outside Antenna cable is connected before powering up the Sleek.*

**NOTE:** *The 12V DC power source on many vehicles is shut off with the ignition key.*

**IMPORTANT:** *Use only the supplied Wilson Electronics power supply.*

Sleek 4G Bottom View

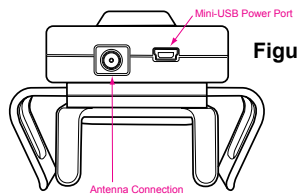

Figure 1

Sleek 4G Side View

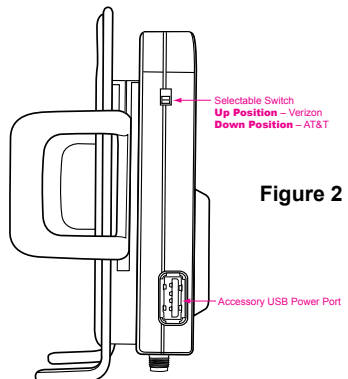

Figure 2

## Adjusting the Sleek® 4G Arms

Included with your Sleek 4G are various sized arms, which will provide you with multiple options to customize the Sleek 4G to fit your phone.

**Note:** Figures 3 & 4 indicate slots used for adjustable arms.

Figure 3

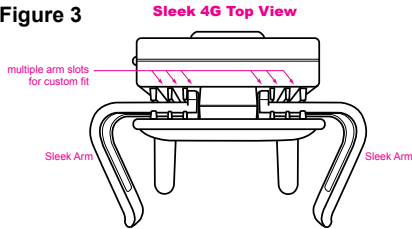

Sleek 4G Front View

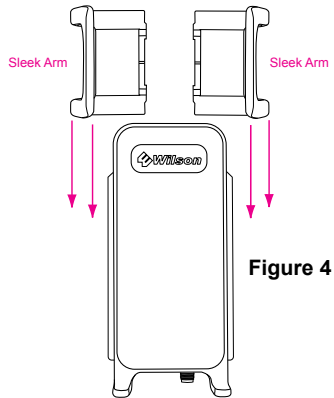

Figure 4

## Understanding the Sleek® 4G Lights

**Separation of Sleek 4G and the Outside Antenna is very important.** In a vehicle, the metal roof acts as a barrier and helps shield the two antennas from each other, preventing oscillation (feedback).

Oscillation can occur when the roof mounted antenna is too close to the Sleek 4G inside the vehicle. An oscillation (or feedback) in the Sleek 4G is similar to when a microphone is too close to a speaker in sound system, resulting in a loud whistle. An oscillation in the Sleek 4G, if allowed to occur, can affect nearby cell towers' ability to handle calls.

### Sleek® 4G SYMPTOM: Red light is on

The Sleek 4G has oscillation protection – which means the Signal Booster powers down to protect the cell tower. See section above “Separation of Sleek 4G and the Outside Antenna is very important.” The RED light indicates the outside roof mounted antenna needs to be farther apart from the Sleek 4G. In a vehicle installation, move the Outside Antenna on the roof of the car farther to the rear of the car, but at least 6 inches from the rear and side windows or sunroof. To reset the Sleek 4G, disconnect and reconnect the power supply. If the light is now green, the Sleek 4G is working properly. If the RED light is still on, move the Outside Antenna farther away and repeat the process.

**NOTE:** The cell phone must be placed in the Sleek 4G to work properly. Use a Bluetooth® or hands free device.

### Troubleshooting

#### SYMPTOM: No increase in bars

1. Make sure that the antenna connector is tight.
2. **The cell phone must be placed in the Sleek 4G cradle to amplify properly.**
3. Call Wilson Electronics Technical Support at 866-294-1660.

## In-Building Installation

### Installing a Wilson Electronics Outside Antenna in a Building

Follow the specific antenna instructions included with the Outside Antenna (sold separately except for certain kits). These instructions assume that you are using a Wilson Electronics Mini-Magnet Mount Antenna and the optional suction cup window bracket.

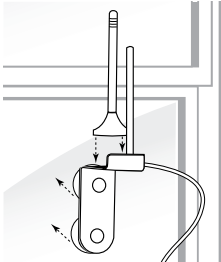

To receive the best signal, select a window on the side of your building where your outside signal is the strongest.

Attach the suction cup bracket to the inside of a window so that the cable will reach the location of the Sleek 4G. Place the bracket as high on the window as possible for best performance.

Once the bracket is in place, attach the magnet base of the antenna to the flat surface of the bracket. **Note:** The antenna must be installed vertically. Signal performance will be degraded if the antenna is not vertical.

### Installing the Wilson Electronics Sleek 4G® Signal Booster in a Building

The Wilson Electronics Sleek 4G may be placed in any convenient indoor location, such as a desk or tabletop. The cell phone or data card must be in the cradle and use a Bluetooth® headset or wired hands free device for voice communications.

#### Attaching the Antenna

Once you have selected the location for the Sleek 4G, run the cable from the Outside Antenna and attach it to the connector on the bottom of the Sleek 4G.

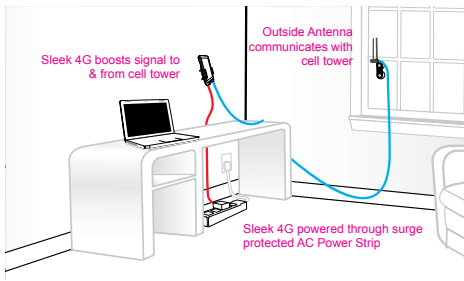

**NOTE:** The cell phone must be placed in the Sleek 4G cradle to amplify properly.



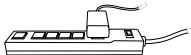

**NOTE:** The Sleek 4G and the Outside Antenna must have a minimum separation of 3 feet to prevent oscillation.

#### IMPORTANT NOTICE



- It is very important to power your Signal Booster using a surge protected AC Power Strip with at least a **1000 Joule rating**.
- Failure to do this will void your warranty in the event of a power surge or lightning strike.

## Warnings

-  Warning: Do not plug in the power supply until the Outside Antenna cable is attached to the Sleek.
-  Warning: **RF Safety:** The Sleek cradle/Signal Booster must not be used in conjunction with any other antenna or Signal Booster.
-  Warning **RF Safety:** The FCC requires that a cell phone with cradle attached may only be used with the cradle mounted as illustrated in this installation guide. A cell phone held near the ear must be without the cradle attached.
-  Warning: **RF Safety:** All Inside Antennas used with this Signal Booster may not have gain (less cable loss) that exceeds 15 dBi and must be located at least 8.5 inches from all people. Outside antennas may not have gain that exceeds 3.4 dBi (less cable loss) and must be located least 9 inches from all people. All antennas shown on page one meet these requirements.
-  Warning: DO NOT use phone covers that have chrome or any other metallic surface. It may block cellular signals.

This device complies with part 15 of the FCC Rules. Operation is subject to the following two conditions: (1) This device may not cause harmful interference, and (2) this device must accept any interference received, including interference that may cause undesired operation. Changes or modifications made that are not expressly approved by Wilson Electronics could void authority to operate this equipment.

## About Wilson Electronics

Wilson Electronics, Inc. has been a leader in the wireless communications industry for over 40 years. The company designs and manufactures Signal Boosters, antennas and related components that significantly improve cellular phone signal reception and transmission in a wide variety of applications, both mobile (marine, RV, vehicles) and in-building (home, office, M2M).

With extensive experience in antenna and Signal Booster research and design, the company's engineering team uses a state-of-the-art testing laboratory, including an anechoic chamber and network analyzers, to fine-tune antenna designs and performance. For its Signal Boosters, Wilson Electronics uses a double electrically shielded RF enclosure and cell tower simulators for compliance testing. Wilson Electronics Signal Boosters feature patented Smart Technology II™ that enables them to automatically adjust their power based on cell tower requirements. By detecting and preventing oscillation (feedback), signal overload and interference with other users, these Smart Technology II™ Signal Boosters improve network cell phone areas without compromising carrier systems.

All products are engineered and assembled in the company's 55,000-square-foot headquarters in St. George, Utah. Wilson Electronics has product dealers in all 50 states as well as in countries around the world.

### 30-Day Money-Back Guarantee

All Wilson Electronics products are protected by Wilson Electronics 30-day money-back guarantee. If for any reason the performance of any product is not acceptable, simply return the product directly to the reseller with a dated proof of purchase.

### 1-Year Warranty

Wilson Electronics Signal Boosters are warranted for one (1) year against defects in workmanship and/or materials. Warranty cases may be resolved by returning the product directly to the reseller with a dated proof of purchase.

Signal Boosters may also be returned directly to the manufacturer at the consumer's expense, with a dated proof of purchase and a Returned Material Authorization (RMA) number supplied by Wilson Electronics. Wilson Electronics shall, at its option, either repair or replace the product. Wilson Electronics will pay for delivery of the repaired or replaced product back to the original consumer if located within the continental U.S.

This warranty does not apply to any Signal Booster determined by Wilson Electronics to have been subjected to misuse, abuse, neglect, or mishandling that alters or damages physical or electronic properties.

Failure to use a surge protected AC Power Strip with at least a 1000 Joule rating will void your warranty.

RMA numbers may be obtained by contacting Technical Support at 866-294-1660.

**Disclaimer :** The information provided by Wilson Electronics, Inc. is believed to be complete and accurate. However, no responsibility is assumed by Wilson Electronics, Inc. for any business or personal losses arising from its use, or for any infringements of patents or other rights of third parties that may result from its use.

## Signal Booster Specifications

	Sleek 4G				
Model Number	2B3425				
Connectors	SMA Female				
Impedance (input/output)	50 ohms				
Frequency	698-746 MHz / 746-787 MHz / 824-894 MHz / 1850-1995 MHz / 1710-2155 MHz				
Power output for single cell phone (uplink) dBm	700 MHz (band 12/17)	700 MHz (band 13)	800 MHz	1900 MHz	1700/2100 MHz
	Uplink	27.9	28	28.6	28.2
	Downlink	3.1	3.6	2.4	9.2
Noise Figure (typical)	3 dB nominal				
Isolation	> 40 dB				
Power Requirements	5.5V DC, 2.5 A				



3301 East Deseret Drive, St. George, UT 84790  
For additional Technical Support visit [www.WilsonElectronics.com](http://www.WilsonElectronics.com)  
or email at: [tech@wilsonelectronics.com](mailto:tech@wilsonelectronics.com)  
Phone: 866-294-1660 Local: 435-673-5021 Fax: 435-656-2432  
[www.twitter.com/WilsonCellular](http://www.twitter.com/WilsonCellular) [www.facebook.com/WilsonCellular](http://www.facebook.com/WilsonCellular)